



Radio | CD | MP3 | WMA

London MP37



7 647 553 310

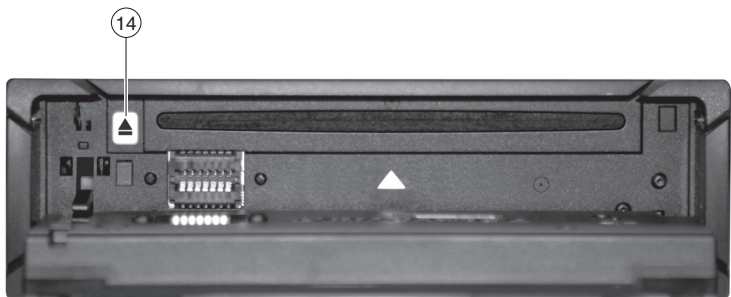
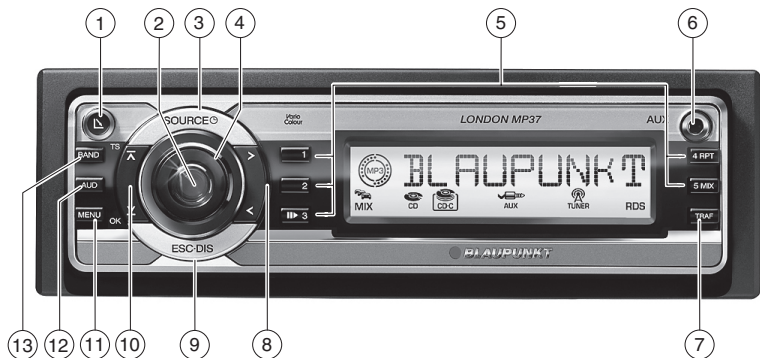

Bedienungsanleitung
Operating instructions
Mode d'emploi
Istruzioni d'uso
Gebruiksaanwijzing
Bruksanvisning
Instrucciones de manejo
Instruções de serviço
Betjeningsvejledning
Instrukcja obsługi
Návod k obsluze
Návod na obsluhu

 **BLAUPUNKT**



- ①  button to open the flip-release control panel.
- ② On/Off button
Short press: Switches the device on. In operation: Mutes the device.
Long press: Switches the device off.
- ③ **SOURCE**  button
Short press: Source selection between radio and CD and (if connected or switched on) CD changer, AUX and FRONT AUX.
Long press: Briefly displaying time.
- ④ Volume control
- ⑤ Keys **1 - 5**
- ⑥ **FRONT AUX** input
- ⑦ **TRAF•RDS** button
Short press: Switches traffic information standby on/off.
Long press: Switches convenient RDS function on/off.
- ⑧ Arrow keys **<** and **>**
- ⑨ **ESC•DIS** button
Short press: Changes from a menu item back to the main menu (also in Audio menu).
Long press: Changes display contents.
- ⑩ Arrow keys **↖** and **↘**
- ⑪ **MENU•OK** button
Short press: Calls up the menus for basic settings and confirms settings. Ending the scan function.
Long press: Starts the Scan function.
- ⑫ **AUD** button to call up the Audio menu: Adjusting bass, treble, middle, subout, balance and fader.
Switching X-BASS on/off and adjusting it.
Selects an equaliser presetting.
- ⑬ **BAND•TS** button
Short press: Selects the FM memory banks and the MW and LW wavebands.
Long press: Starts the Travelstore function.
- ⑭  button (Eject) for removing a CD from the device.

About these instructions	40	Listening to stored stations	50
Symbols used.....	40	Scanning receivable stations (SCAN) ...	50
Use as directed.....	40	Setting the scanning time.....	50
Declaration of conformity.....	40	Programme type (PTY)	51
For your safety	41	Optimising radio reception	52
If you are installing device yourself....	41	Traffic information.....	53
Cleaning notes.....	41	Switching traffic information	
Disposal of old unit		priority on/off	53
(EU countries only)	42	Setting the volume for traffic	
Scope of delivery	42	announcements.....	53
Optional equipment		CD mode	54
(not part of the scope of delivery)	42	Switching to CD mode	54
Warranty	43	Selecting tracks	54
Service	43	Fast track selection	54
Detachable control panel	43	Fast searching (audible).....	55
Theft protection.....	43	Random track play (MIX)	55
Detaching the control panel.....	43	Scanning tracks (SCAN).....	55
Attaching the control panel.....	44	Repeating tracks (Repeat).....	55
Switch-off time (OFF TIMER)	44	Interrupting playback (PAUSE).....	55
Switching on/off	45	Configuring the display	56
Adjusting the volume	45	Displaying CD text.....	56
Setting the power-on volume	45	Traffic announcements in CD mode ..	56
Quickly reducing the volume (Mute) ..	46	Ejecting a CD.....	56
Telephone Audio/Navigation Audio ...	46	MP3/WMA mode	57
Switching the confirmation		Preparing an MP3 CD	57
beep on/off.....	47	Switching to MP3 mode	58
Radio mode	47	Configuring the display	58
Adjusting the tuner.....	47	Selecting a directory	59
Switching to radio mode	48	Selecting tracks/files.....	59
Convenient RDS functions (AF, REG) ...	48	Fast search	59
Selecting the waveband/		Random track play – MIX.....	59
memory bank	48	Scanning tracks – SCAN	60
Tuning into a station	49	Repeated playback of individual	
Setting the sensitivity of station seek		tracks or entire directories – REPEAT ...	60
tuning	49	Interrupting playback (PAUSE).....	60
Storing stations	50		
Storing stations automatically			
(Travelstore)	50		

CD-changer mode	61	Adjusting the display settings	68
Switching to CD-changer mode	61	Adjusting the display brightness.....	68
Selecting CDs.....	61	Setting the display illumination	
Selecting tracks.....	61	colour	68
Fast searching (audible).....	61	External audio sources	69
Repeating individual tracks or whole		Switching the rear AUX input on/off ..	70
CDs (REPEAT)	61	Technical data	70
Random track play (MIX)	61		
Scanning all tracks on all CDs (SCAN)...	62		
Interrupting playback (PAUSE).....	62		
Configuring the display	62		
Clock - Time	63		
Displaying the time	63		
Setting the time	63		
Selecting 12/24-hour clock mode	63		
Displaying the time continuously			
when the device is off and the			
ignition is on	63		
Sound	64		
Adjusting the bass	64		
Adjusting the middle	64		
Adjusting the treble.....	65		
Setting the left/right volume			
distribution (Balance)	65		
Adjusting the front/rear volume			
distribution (Fader).....	65		
Preamplifier output			
(Preamp-Out/Sub-Out)	66		
Adjusting the sub-out level	66		
Adjusting the sub-out cutoff			
frequency	66		
X-BASS	67		
Adjusting the X-BASS boost.....	67		
Equalizer presettings (Presets)	67		

About these instructions

These instructions contain important information to easily and safely install and operate the device.

- Read these instructions carefully and completely before using the device.
- Keep the instructions at a location so that they are always accessible to all users.
- Always pass on the device to third parties together with these instructions.

In addition, observe the instructions of the devices used in conjunction with this device.

Symbols used

These instructions employ the following symbols:



DANGER!

Warns about injuries



CAUTION!

Warns about laser beam



CAUTION!

Warns about damaging the CD drive



The CE mark confirms the compliance with EU directives.

➔ Identifies a sequencing step

- Identifies a listing

Use as directed

This device is intended for installation and operation in a vehicle with 12 V vehicle system voltage and must be installed in a DIN slot. Observe the performance limits in the technical data. Repairs and installation, if necessary, should be performed by a specialist.

Declaration of conformity

The Blaupunkt GmbH declares that this car sound system complies with the basic requirements and the other relevant regulations of the directive 1999/5/EG.

For your safety

The device was manufactured according to the state of the art and established safety guidelines. Even so, dangers may occur if you do not observe the safety notes in these instructions:

If you are installing device yourself

You may only install the device yourself if you are experienced in installing car sound systems and are very familiar with the electrical system of the vehicle. For this purpose, observe the installation instructions at the end of these instructions.

Observe the following!



DANGER!

Increased risk of injury from connector

In case of an accident, the protruding connector in the FRONT-AUX-IN socket may cause injuries. The use of straight plugs or adapters can lead to an increased risk of injury.

- For this reason, we recommend using angled jack plugs, e.g. the Blaupunkt accessories cable (7 607 001 535).



CAUTION!

The device contains a Class 1 laser that can cause injuries to your eyes.

Do not open the device and do not perform any modifications.

In operation

- Operate the device only if traffic situation permits it! Stop at a suitable location to perform more extensive operations.
- Remove or attach the control panel only while the vehicle is standing an.
- Always listen at a moderate volume so that you can hear acoustic warning signals (e.g. police sirens) and protect your hearing. Do not increase the volume when selecting a different audio source or while the CD changer changes the CD. The device is briefly muted.

After operation

- The device is worthless to a thief without the control panel. Always remove the control panel whenever you leave the vehicle.
- Transport the control panel so that it is protected against impacts and the contacts cannot become dirty.

Cleaning notes

Solvents, cleaning and scouring agents as well as dashboard spray and plastics care product may contain ingredients that will damage the surface of the device.

- Use only a dry or slightly moistened cloth for cleaning the device.
- If necessary, clean the contacts of the control panel regularly using a soft cloth moistened with cleaning alcohol.

Disposal of old unit

(EU countries only)



Do not dispose of your old unit in the household trash!

Use the return and collection systems available to dispose of the old device.

Scope of delivery

The scope of delivery includes:

- 1 Car sound system
- 1 Case for the control panel
- 1 Support frame
- 2 Disassembly bar
- 1 Guide pin
- 1 Operating instructions

Optional equipment

(not part of the scope of delivery)

Use only accessories approved by Blaupunkt.

Remote control

The steering wheel and/or handheld remote control allows you to access the basic functions of your car sound system safely and conveniently.

You cannot switch the device on/off using the remote control!

You can find out from your Blaupunkt dealer or on the Internet at www.blaupunkt.com which remote controls can be used with your car sound system.

Amplifier

You can use all Blaupunkt and Velocity amplifiers.

CD changers

You can connect the following Blaupunkt CD changers:
CDC A 03, CDC A 08 and IDC A 09.

Warranty

We provide a manufacturer's warranty for products bought within the European Union. Devices purchased outside the European Union are subject to the warranty terms published by our respective regional agency.

The warranty terms can be called up under www.blaupunkt.com or requested directly from:

Blaupunkt GmbH
Hotline
Robert-Bosch-Str. 200
D-31139 Hildesheim

Service

In some countries, Blaupunkt offers a repair and pick-up service.

Information about the availability of this service in your country can be found at www.blaupunkt.com.

If you want to take advantage of this service, you may request a pick-up service for your device via the Internet.

Detachable control panel

Theft protection

The device is equipped with a detachable control panel (flip-release panel) as a way of protecting your equipment against theft. The device is worthless to a thief without this control panel.

Protect your device against theft by taking the control panel with you whenever you leave your vehicle. Do not leave the control panel inside your vehicle - not even in a hiding place.

Notes:

- Never drop the control panel.
- Never expose the control panel to direct sunlight or other heat sources.
- Avoid direct skin contact with the control panel's electrical contacts. If necessary, please clean the contacts with a lint-free cloth moistened with cleaning alcohol.

Detaching the control panel

➡ Press the  button ①.

The control panel opens out towards you.

➡ Hold the control panel by its right side and then pull the control panel straight out of the bracket.

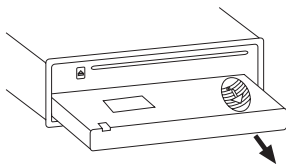

Notes:

- The device is switched off after a time preset by you. For instructions, please read the section "Switch-off time (OFF TIMER)" in this chapter.
- All the current settings are saved.
- Any CD already inserted in the device remains there.

Attaching the control panel

- Hold the control panel approximately at a right angle to the device.
- Slide the control panel into the device's guides that are positioned on the left and right at the lower edge of the housing. Push the control panel carefully into the bracket until it clicks into place.
- Carefully flip up the control panel until it clicks into place.

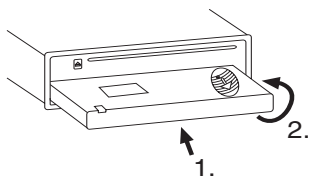

If the device was still switched on when you detached the control panel, it will automatically switch on with the last setting activated (radio, CD, CD changer or AUX) when the panel is replaced.

Switch-off time (OFF TIMER)

After opening the control panel, the device is switched off after an adjustable time. You can set this time from 0 to 30 seconds.

- Press the **MENU** button (11).
- Press the **√** or **∧** button (10) repeatedly until the displays shows "OFF TIMER".
- Press the **<** or **>** button (8) to open the menu.
- Set the time with the **<** or **>** button (8).

When you have finished making your changes,

- press the **MENU** button twice (11).

Note:

If you set the switch-off time to 0 seconds, the device is switched off immediately after opening the control panel.

Switching on/off

There are various ways of switching the device on/off:

Switching on/off using button ②

- To switch on the device, press button ②.

The device switches on.

- To switch off the device, press and hold down button ② for longer than two seconds.

The device switches off.

Switching on/off using the vehicle ignition

The device will switch on/off simultaneously with the ignition if the device is correctly connected to the vehicle's ignition as shown in the installation instructions and you did not switch the device off by pressing button ②.

Switching the device on/off using the detachable control panel

- Detach the control panel.

The device switches off after the time set in the "OFF TIMER" menu.

- Attach the control panel again.

The device switches on. The last setting (radio, CD, CD changer or AUX) is reactivated.

Note:

To protect the vehicle battery, the device will switch off automatically after one hour if the ignition is off.

Adjusting the volume

You can adjust the volume in increments from 0 (off) to 66 (maximum).

To increase the volume,

- turn the volume control ④ clockwise.

To decrease the volume,

- turn the volume control ④ counter-clockwise.

Setting the power-on volume

Note:

The device features a time-out function (time window).

For example, if you press the **MENU** button ⑪ and select a menu item, the device switches back after approx. 8 seconds after the last button activation. The settings performed are saved.

You can set the power-on volume.

- Press the **MENU** button ⑪.
- Press the **∨** or **∧** button ⑩ repeatedly until "ON VOLUME" appears on the display.
- Press the **<** or **>** button ⑧ to open the menu.
- Set the power-on volume with the **<** or **>** button ⑧.

To help you adjust the setting more easily, the device will increase or decrease the volume as you make your changes.

If you enable "LAST VOL", the volume which was set the last time you switched off the device is re-enabled.

Note:

To protect your hearing, the power-on volume is limited to the value "38" for the setting "LAST VOL". If the volume was higher before switch-off, the value is automatically set to "38" at switch-on. This prevents an unintentionally and unexpectedly high volume when switching on the device.

When you have finished making your changes,

➔ press the **MENU** button twice (11).

Quickly reducing the volume (Mute)

You can quickly reduce the volume to a preset level (Mute).

➔ Briefly press button (2).

"MUTE" appears on the display.

Cancelling mute

To return to your previously set volume level,

➔ briefly press button (2) again.

Adjusting the mute level

You can adjust the mute level.

➔ Press the **MENU** button (11).

➔ Press the **∨** or **∧** button (10) repeatedly until "MUTE LVL" appears on the display.

➔ Press the **<** or **>** button (8) to open the menu.

➔ Set the mute level with the **<** or **>** button (8).

When you have finished making your changes,

➔ press the **MENU** button twice (11).

Telephone Audio/Navigation Audio

If your car sound system is connected to a mobile telephone or a navigation system, the sound system's volume will be muted as soon as you "pick up" the phone or as soon as a navigation announcement is made. You will then hear the caller or navigation announcement over the car sound system's loudspeakers. In order for this feature to work, the mobile telephone or navigation system must be connected to the car sound system as described in the installation instructions.

You can find out from your Blaupunkt dealer which navigation systems can be used with your car sound system.

If the sound system receives a traffic announcement during a telephone call or whilst a navigation announcement is being made, you will only be able to hear the traffic announcement after the call or navigation announcement is finished (in so far as the traffic announcement is still being broadcast). The traffic announcement is not recorded!

You can adjust the volume with which you switch on the telephone calls or the voice output of the navigation.

➔ Press the **MENU** button (11).

➔ Press the **∨** or **∧** button (10) repeatedly until "TEL VOL" appears on the display.

➔ Press the **<** or **>** button (8) to open the menu.

- Set the desired volume with the < or > button (8).

When you have finished making your changes,

- press the **MENU** button twice (11).

Note:

You can use the volume control (4) to adjust the volume of telephone calls and navigation announcements whilst you are listening to them.

Switching the confirmation beep on/off

The system will output a confirmation beep for some functions if you keep a button pressed down for longer than two seconds, for instance, when assigning a radio station to a station preset button. You can switch the beep on or off.

- Press the **MENU** button (11).
- Press the **√** or **∧** button (10) repeatedly until "BEEP ON" or "BEEP OFF" appears on the display.
- Switch the BEEP ON or OFF with the < or > button (8).

When you have finished making your changes,

- press the **MENU** button (11).

Radio mode

This device is equipped with an RDS radio receiver. Many of the receivable FM stations broadcast a signal that not only carries the programme but also additional information such as the station name and programme type (PTY).

The station name appears on the display as soon as the tuner receives it.

Adjusting the tuner

To ensure proper functioning of the tuner, the device must be set for the region in which it is being operated. You can select among Europe "EUROPE", America "USA", South America "S-AMERICA", and Thailand "THAI". The tuner is factory-set to the region in which it was sold. If you experience problems with your radio reception, please check this setting.

The radio functions described in these operating instructions refer to the tuner setting EUROPE.

- Switch off the device by pressing button (2).
- Hold the buttons **1** and **5** (5) pressed at the same time and switch on the device again with the button (2).

"TUNER" is displayed.

- Select your tuner region with the **√** or **∧** button (10).

To save the setting,

- switch the device off and on again or wait approx. 8 seconds. The radio starts playing with the last setting selected (radio, CD, CD changer or AUX).

Switching to radio mode

If you are in CD, CD changer or AUX mode,

➤ press the **BAND•TS** button (13)

or

➤ press the **SOURCE** button (3) repeatedly until the memory bank, e.g. "FM1", appears on the display.

Convenient RDS functions (AF, REG)

The convenient RDS functions AF (Alternative Frequency) and REGIONAL extend your radio's range of functions.

- AF: If the RDS function is activated, the radio automatically tunes into the best receivable frequency for the station that is currently set.
- REGIONAL: At certain times, some radio stations divide their programme into regional programmes providing different content. You can use the REG function to prevent the car radio from switching to alternative frequencies that are transmitting different programme content.

Note:

REGIONAL must be activated/deactivated separately in the menu.

Switching REGIONAL on/off

➤ Press the **MENU** button (11).

➤ Press the **√** or **∧** button (10) repeatedly until "REG" appears on the display.

"OFF" or "ON" is displayed alongside "REG".

To switch REGIONAL on/off,

➤ press the **<** or **>** button (8).

When you have finished making your changes,

➤ press the **MENU** button (11).

Switching the RDS function on/off

To switch the RDS functions AF and REGIONAL on or off,

➤ press and hold down the **TRAF•RDS** button (7) for longer than two seconds.

If the RDS comfort function is active, RDS appears on the display.

Selecting the waveband/memory bank

This device can receive programmes broadcast over the FM frequency range as well as the MW and LW (AM) wavebands. There are three memory banks available for the FM waveband (FM1, FM2 and FMT) and one for each of the MW and LW wavebands.

Five stations can be stored in each memory bank.

To switch between the FM memory banks (FM1, FM2 and FMT) and the MW and LW wavebands,

➤ briefly press the **BAND•TS** button (13).

Tuning into a station

There are various ways of tuning into a station.

Automatic station seek tuning

➤ Press the **V** or **^** button (10).

The radio tunes into the next receivable station.

Note:

If the priority for traffic information is active (the display shows the traffic jam symbol), the next traffic information station is set.

Tuning into stations manually

You can also tune into stations manually.

Note:

You can only tune into stations manually if the RDS function is deactivated.

To change the set frequency in small increments,

➤ briefly press the **<** or **>** button (8).

To change the set frequency quickly,

➤ press and hold down the **<** or **>** button (8) for a longer period of time.

Browsing through broadcasting networks (FM only)

If a radio station provides several programmes, you have the option of browsing through its so-called "broadcasting network".

Note:

The convenient RDS function must be activated before you can use this feature.

➤ Press the **<** or **>** button (8) to switch to the next station on the broadcasting network.

Note:

When using this feature, you will only be able to switch to stations that you have received once before already. To receive the stations, use the Scan or Travelstore function.

Setting the sensitivity of station seek tuning

You can choose whether the radio should only tune into stations providing good reception or whether it can also tune into those with a weak reception.

➤ Press the **MENU** button (11).

➤ Press the **V** or **^** button (10) repeatedly until "SENS HI" or "SENS LO" appears on the display.

The display shows the currently set sensitivity level. "SENS HI3" indicates the highest sensitivity, "SENS LO1" the lowest.

➤ Set the desired sensitivity with the **<** or **>** button (8).

When you have finished making your changes,

➤ press the **MENU** button (11).

Note:

The device stores the sensitivity value set in the respective FM and AM waveband.

Storing stations

Storing stations manually

- Select the desired memory bank (FM1, FM2, FMT) or one of the wavebands (MW or LW).
- Tune into the desired station.
- Press and hold down one of the station buttons **1 - 5** (5) for longer than two seconds to assign the station to that button.

Storing stations automatically (Travelstore)

You can automatically store the five stations offering the strongest reception in the region (FM only). The stations are stored in the FMT memory bank.

Note:

Any stations that were previously stored in this memory bank are deleted in the process.

- Press and hold down the **BAND•TS** button (13) for longer than two seconds.

The storing procedure begins. "FMTSTORE" appears on the display. After the process has completed, the radio will play the station that is stored in memory location 1 of the FMT memory bank.

Note:

If the priority for traffic information is active (the display shows the traffic jam symbol), only traffic information stations are stored.

Listening to stored stations

- Select the memory bank or waveband.
- Press one of the station buttons **1 - 5** (5).

The stored station is played if it can be received.

Scanning receivable stations (SCAN)

You can use the scan function to play all the receivable stations briefly. You can set the scanning time in the menu to between 5 and 30 seconds.

Starting SCAN

- Press and hold down the **MENU** button (11) for longer than two seconds.

The radio scans the next receivable station. The current memory bank and "SCAN" appear briefly on the display followed by a flashing display of the current station name or frequency.

Cancelling the SCAN and continuing to listen to a station

- Press the **MENU** button (11).

Scanning stops and the radio continues playing the station that it tuned into last.

Setting the scanning time

- Press the **MENU** button (11).
- Press the **∨** or **∧** button (10) repeatedly until "SCAN TIME" appears on the display.
- Press the **<** or **>** button (8) to open the menu.
- Set the desired scan time with the **<** or **>** button (8).

When you have finished making your changes,

➔ press the **MENU** button twice (11).

Note:

The defined scanning time is also applied by the system to scanning carried out in CD and CD changer mode.

Programme type (PTY)

Besides transmitting the station name, some FM stations also provide information on the type of programme that they are broadcasting. Your car radio can receive and display this information.

For example, the programme types can be:

CULTURE	TRAVEL	JAZZ
SPORT	SERVICE	POP
ROCK	KNOWLEDGE	KIDS

You can use the PTY function to select stations of a particular programme type.

PTY-EON

If you specify the programme type and start seek tuning, the radio will switch from the current station to a station of the selected programme type.

Notes:

- If the tuner does not find a station that corresponds to the selected programme type, you will hear a beep and "NO PTY" appears briefly in the display. The radio will then retune to the station that it received last.
- If the tuned radio station or another station on the broadcasting network broadcasts your selected programme type at a later point in time, the radio

will automatically switch from the currently tuned station or from CD mode or CD-changer mode to the station whose programme type matches the one you selected.

- If you want to deactivate this PTY EON switching, you must disable PTY in the menu with "PTY OFF". In CD or CD changer mode, the menu item "PTY ON/ OFF" is not available. Instead, use the **SOURCE** button (3) or **BAND-TS** button (13) to change to radio mode first.

Switching PTY on/off

- ➔ Press the **MENU** button (11).
- ➔ Press the **√** or **∧** button (10) repeatedly until "PTY" appears on the display with the current setting.
- ➔ Press the **<** or **>** button (8) to switch PTY ON or OFF.

When you have finished making your changes,

➔ press the **MENU** button (11).

Selecting the PTY language

You can select the language for the display of the programme types. Options include DEUTSCH, ENGLISH and FRANÇAIS.

- ➔ Press the **MENU** button (11).
- ➔ Press the **√** or **∧** button (10) repeatedly until "PTY LANG" appears on the display.
- ➔ Press the **<** or **>** button (8) to open the menu.
- ➔ Set the desired language using the **<** or **>** buttons (8).

Radio mode

When you have finished making your changes,

➤ press the **MENU** button twice (11).

Selecting a programme type and starting seek tuning

➤ Press the < or > button (8).

The current programme type appears on the display.

➤ If you want to select another programme type, you can do so by pressing the < or > button (8) whilst this display is visible.

The selected programme type appears briefly on the display.

➤ Press the **V** or **A** button (10) to start seek tuning.

The radio will then tune into the next station that it finds that corresponds to your selected programme type.

Optimising radio reception

Treble reduction feature during interference (High Cut)

The High Cut function results in an improved reception in case of weak radio reception (FM only). If reception interferences are present, the interference level is automatically reduced.

Switching High Cut on/off

➤ Press the **MENU** button (11).

➤ Press the **V** or **A** button (10) repeatedly until "HICUT" appears on the display with the current setting.

➤ Press the < or > button (8) to switch High Cut on or off.

"HICUT 0" means no automatic reduction of the interference level, "HICUT 1" means automatic reduction of the interference level.

When you have finished making your changes,

➤ press the **MENU** button (11).

Traffic information

Your device is equipped with an RDS-EON receiver. EON (**E**nanced **O**ther **N**etwork) ensures that whenever a traffic announcement (TA) is broadcast, the system switches automatically from a station that does not provide traffic reports to the appropriate traffic information station within the broadcasting network that does.

Once the traffic report has been played, the system will switch back to the programme that you were listening to before.

Switching traffic information priority on/off

➔ Press the **TRAF•RDS** button (7).

The priority for traffic announcements is activated if the display shows the traffic jam symbol.

Notes:

You will hear a warning beep:

- If you leave the reception area of a traffic information station that you are currently listening to.
- If you leave the reception area of a traffic information station that the system is tuned into while you are in the CD or CD changer mode, and the subsequent automatic seek tuning cannot find a new traffic information station.
- If you retune the radio from a traffic information station to a station that does not broadcast traffic information.

If you hear the warning beep, you can either switch off traffic information priority or tune into a station that broadcasts traffic information.

Setting the volume for traffic announcements

- ➔ Press the **MENU** button (11).
- ➔ Press the **∨** or **∧** button (10) repeatedly until "TA VOLUME" appears on the display.
- ➔ Press the **<or>** button (8) to open the menu.
- ➔ Set the volume using the **<or>** button (8).

To help you adjust the setting more easily, the device will increase or decrease the volume as you make your changes.

When you have finished making your changes,

- ➔ press the **MENU** button twice (11).

Notes:

- Using the volume control (4), you can also adjust the volume during a traffic announcement for the duration of that announcement.
- You can adjust the sound settings and volume distribution settings for traffic announcements. For further information, please read the "Sound" chapter.

CD mode

You can use this device to play standard audio CDs, CD-Rs and CD-RWs with a diameter of 12 cm. To avoid problems when playing self-burned CDs, you should not burn CDs at speeds greater than 16-speed.



Risk of severe damage to the CD drive!

CD singles with a diameter of 8 cm and non-circular contoured CDs (shape CDs) must not be used.

We accept no responsibility for any damage to the CD drive that may occur as a result of the use of unsuitable CDs.

To ensure proper functioning, use only CDs with the Compact-Disc logo. Copy-protected CDs can cause playback problems. Blaupunkt cannot guarantee the proper functioning of copy-protected CDs!

Besides being able to play audio CDs on this device, you can also play CDs containing MP3/WMA music files. For further information, please read the chapter entitled "MP3/WMA mode".

Switching to CD mode

If there is no CD inserted in the drive,

➤ press the  button (1).

The control panel opens.

➤ Gently insert the CD with its printed side uppermost into the drive until you feel some resistance.

The drive draws in the CD automatically.

You must not hinder or assist the drive as it draws in the CD.

➤ Gently close the control panel whilst exerting a little pressure until you feel it click into place.

The CD playback starts and "CD" is shown on the display.

Note:

If the vehicle ignition was switched off prior to inserting the CD, you must switch the device on first with the button (2) to start the playback.

If a CD is already inserted in the drive,

➤ press the **SOURCE** button (3) repeatedly until "CD" appears on the display.

Playback begins from the point at which it was last interrupted.

Selecting tracks

➤ Press an arrow button (8) or (10) to select the next or previous track.

If you press the **▼** button (10) or **<** button (8) once, the player will play the current track again from the beginning.

Fast track selection

To quickly select tracks backwards or forwards,

➤ press and hold down the **↔** or **▼** button (10) until fast track selection backwards/forwards begins.

Fast searching (audible)

To fast search backwards or forwards,

- press and hold down the < or > button (8) until fast searching backwards/forwards begins.

Random track play (MIX)

- Press the **5 MIX** button (5).

"MIX CD" appears briefly on the display and the MIX symbol is displayed. The next randomly selected track will then be played.

Cancelling MIX

- Press the **5 MIX** button (5) again.

"MIX OFF" appears briefly on the display and the MIX symbol disappears.

Scanning tracks (SCAN)

You can scan (briefly play) all the tracks on the CD.

- Press the **MENU** button (11) for longer than two seconds.

The next track will then be scanned. The display briefly shows "TRK SCAN". The flashing track number is displayed next.

Note:

You can set the scanning time. For further information, please read the section entitled "Setting the scanning time" in the "Radio mode" chapter.

Cancelling Scan and continuing listening to a track

To end the scanning process,

- press the **MENU** button (11).

The currently scanned track will then continue to be played normally.

Repeating tracks (Repeat)

If you want to repeat a track,

- press the **4 RPT** button (5).

"RPT TRCK" appears briefly on the display and the RPT symbol is displayed. The track is repeated continuously until you deactivate Repeat.

Cancelling Repeat

If you want to cancel the repeat function,

- press the **4 RPT** button (5) again.

"RPT OFF" appears briefly on the display and the RPT symbol disappears. Normal playback is then resumed.

Interrupting playback (PAUSE)

- Press the button **3** (5).

"PAUSE" appears on the display.

Cancelling pause

- During the pause, press the button **3** (5).

Playback is continued.

Configuring the display

You can choose from various display options in CD mode:

- Track number and playing time
- Track number and time

To switch between the display options,

- press the **ESC•DIS** button (9) for longer than 2 seconds.

Displaying CD text

Some CDs include CD text. The CD text might contain the names of the artist, album and tracks.

The CD text is shown as scrolling text on the display with every track change.

Switching CD text on/off

- Press the **MENU** button (11).
- Press the **√** or **∧** button (10) repeatedly until "CD TEXT" appears on the display.
- Press the **<** or **>** button (8) to open the menu.
- Select between the options "TEXT ON" (show CD text) or "TEXT OFF" (hide CD text) using the **<** or **>** button (8).

When you have finished making your changes,

- press the **MENU** button twice (11).

Traffic announcements in CD mode

If you wish to receive traffic announcements in CD mode,

- press the **TRAF•RDS** button (7).

The priority for traffic announcements is activated if the display shows the traffic jam symbol. For further details, please read the chapter entitled "Traffic information".

Ejecting a CD

- Press the **⏏** button (1).

The control panel opens out towards you.

- Press the button **▲** (14) next to the CD compartment.

The CD is ejected.

- Remove the CD and close the control panel.

Notes:

- If a CD is ejected, the drive will automatically draw it back in again after 10 seconds.
- You can also eject CDs whilst the device is switched off or whilst another audio source is activated.

MP3/WMA mode

You can also use this car sound system to play CD-Rs and CD-RWs that contain MP3 music files. You can also play WMA files. The operation for playing MP3 and WMA files is identical.

Notes:

- WMA files with Digital Rights Management (DRM) from online music shops cannot be played with this device.
- WMA files can only be played back safely if they were created with Windows Media-Player version 8 or later.

Preparing an MP3 CD

The various combinations of CD burners, CD burning software and CD blanks may lead to problems arising with the device's ability to play certain CDs. If problems occur with your own burned CDs, you should try another brand of CD blank or choose another colour of CD blank.

The format of the CD must be ISO 9660 Level 1/Level 2 or Joliet. Other formats cannot be played reliably.

You can create a maximum of 252 directories on a CD. You can use this device to access directories individually.

Regardless of the number of directories on the CD, the device can handle up to 511 MP3 files on a single CD, with a maximum of 255 files in one directory.

This device supports as many subdirectories as your burner software can create despite the fact that the maximum directory depth defined by the ISO 9660 standard is only 8.

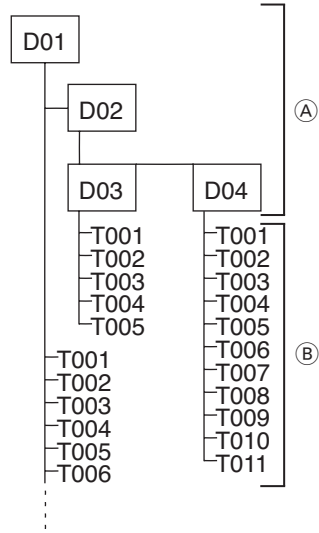

- (A) Directories
(B) Tracks · Files

You can name each directory using a PC. The device is capable of displaying the directory name. Name the directories and tracks/files using your CD burner software. The software's instruction manual will provide details on how to do this.

Note:

When naming directories and tracks/files you should avoid using accents and special characters.

If you like your files to be in the correct order, you should use burner software that places files in alphanumerical order. If your software does not provide this feature you also have the option of sorting the files manually. For this purpose, you must enter a number in front of each file name, e.g. "001", "002", etc. The leading zeros must also be entered.

MP3 tracks can contain additional information such as the artist, album and track names (ID3 tags). This device can display ID3 tags (version 1).

When creating (encoding) MP3 files from audio files, you should use bit rates up to a maximum of 256 Kbit/sec.

This device can only play MP3 files that have the ".MP3" file extension.

Notes:

To ensure uninterrupted playback,

- do not try changing the file extension to ".MP3" of any files other than MP3 files and then attempt to play them! The device will ignore these invalid files during playback.
- Do not use "mixed" CDs containing both non-MP3 data and MP3 tracks (the device only reads MP3 files during MP3 playback).
- Do not use mix-mode CDs containing both CD-audio tracks and MP3 tracks. If you try playing a mix-mode CD, the device will only play the CD-audio tracks.

Switching to MP3 mode

MP3 mode is activated in the same way as normal CD mode. For further information, please read the section entitled "Switching to CD mode" in the "CD mode" chapter.

Configuring the display

Configuring the default display

You can display various types of information on the current track:

- Directory number and playing time
- Track number and playing time
- Track number and time
- Directory number and track number
- Directory number and time

To switch between the different display options,

- ➔ press the **ESC•DIS** button  once or several times for longer than 2 seconds until the desired display is shown.

Configuring the MP3 scrolling texts

One of the following scrolling texts is shown once on the display with every track change. Afterwards, the configured standard display is shown.

The available scrolling texts are:

- Directory name ("DIR NAME")
- Name of the track ("SONG NAME")
- Name of the album ("ALBM NAME")
- Name of the artist ("ARTIST")
- File name ("FILE NAME")

Note:

Artist, track and album name are a component of the MP3 ID tag of version 1 and can only be displayed if they were stored with the MP3 files. For further details, please read the instructions of your PC MP3 software or burner software.

To switch between the different display options,

- press the **MENU** button (11).
- Press the **√** or **⌂** button (10) repeatedly until "MP3 DISP" appears on the display.
- Press the **<or>** button (8) to open the menu.
- Select the desired MP3 scrolling text with the **<or>** button (8).

When you have finished making your changes,

- press the **MENU** button twice (11).

Note:

The "MP3 DISP" menu item is available only during the playback of a CD with MP3/WMA files.

Selecting a directory

To move up or down to another directory,

- press the **√** or **⌂** button (10) once or several times.

Notes:

- The device will automatically skip any directories that do not contain MP3 files. The device will automatically correct the number of directories for the display. This number might there-

fore no longer be identical to the number of directories that you actually created.

- The device treats all directories and subdirectories as if they were located on one level. Repeatedly pressing the **√** or **⌂** button (10) will also bring you to all subdirectories.

Selecting tracks/files

To move up or down to another track/file in the current directory,

- press the **<** or **>** button (8) once or several times.

If you press the **<** button (8) once, the current track will be played again from the beginning.

Fast search

To fast search backwards or forwards,

- press and hold down the **<** or **>** button (8) until fast searching backwards/forwards begins.

Random track play – MIX

To play the tracks in the current directory in random order,

- briefly press the **5 MIX** button (5).

"MIX DIR" appears on the display and the MIX symbol is displayed.

To play the tracks contained in all the directories on the inserted MP3 CD in random order,

- press the **5 MIX** button (5) for longer than two seconds.

"MIX CD" appears on the display and the MIX symbol is displayed.

Cancelling MIX

To cancel MIX,

➤ briefly press the **5 MIX** button (5).

"MIX OFF" appears on the display and the MIX symbol disappears.

Scanning tracks – SCAN

You can scan (briefly play) all the tracks on the CD.

➤ Press the **MENU** button (11) for longer than two seconds.

The next track will then be scanned. "TRK SCAN" briefly appears on the display. The directory number and the track number are displayed next. The track number flashes.

Note:

You can set the scanning time. For further information on setting the scanning time, please read the section entitled "Setting the scanning time" in the "Radio mode" chapter.

Cancelling Scan and continuing listening to a track

➤ Briefly press the **MENU** button (11).

The currently scanned track will then continue to be played normally.

Repeated playback of individual tracks or entire directories – REPEAT

To play the current track repeatedly,

➤ briefly press the **4 RPT** button (5).

"RPT TRCK" appears briefly on the display and the RPT symbol is displayed.

To repeat the whole directory,

➤ press the **4 RPT** button (5) for longer than two seconds.

"RPT DIR" appears briefly on the display and the RPT symbol is displayed.

Cancelling Repeat

To stop the current track or current directory from being repeated,

➤ briefly press the **4 RPT** button (5).

"RPT OFF" appears briefly on the display and the RPT symbol disappears.

Interrupting playback (PAUSE)

➤ Press the button **3** (5).

"PAUSE" appears on the display.

Cancelling pause

➤ During the pause, press the button **3** (5).

Playback is continued.

CD-changer mode

Note:

Information on handling CDs, inserting CDs and operating the CD changer can be found in the operating instructions supplied with your CD changer.

Switching to CD-changer mode

- Press the **SOURCE**  button  repeatedly until "CHANGER" appears on the display.

The device starts playing the first CD that the CD changer detects.

Selecting CDs

To move up or down to another CD,

- press the **↓** or **↑** button  once or several times.

Note:

The device will ignore empty CD slots in the changer and slots containing invalid CDs.

Selecting tracks

To move up or down to another track on the current CD,

- press the **<** or **>** button  once or several times.

Fast searching (audible)

To fast search backwards or forwards,

- press and hold down the **<** or **>** button  until fast searching backwards/forwards begins.

Repeating individual tracks or whole CDs (REPEAT)

To repeat the current track,

- briefly press the **4 RPT** button .

"RPT TRCK" appears briefly on the display and the RPT symbol is displayed.

To repeat the current CD,

- press and hold down the **4 RPT** button  for longer than two seconds.

"RPT DISC" appears briefly on the display and the RPT symbol is displayed.

Cancelling Repeat

To stop the current track or current CD from being repeated,

- briefly press the **4 RPT** button .

"RPT OFF" appears briefly on the display and the RPT symbol disappears.

Random track play (MIX)

To play the tracks on the current CD in random order,

- briefly press the **5 MIX** button .

"MIX CD" appears briefly on the display and the MIX symbol is displayed.

To play the tracks on all inserted CDs in random order,

- press and hold down the **5 MIX** button  for longer than two seconds.

"MIX ALL" appears briefly on the display and the MIX symbol is displayed.

Cancelling MIX

➡ Briefly press the **5 MIX** button (5).

"MIX OFF" appears briefly on the display and the MIX symbol disappears.

Scanning all tracks on all CDs (SCAN)

To scan (briefly play) all the tracks on all the inserted CDs in ascending order,

➡ press the **MENU** button (11) for longer than two seconds.

The next track will then be scanned. The display shows "TRK SCAN". The CD number and the track number are displayed next. The track number flashes.

Stopping Scan

To stop scanning,

➡ briefly press the **MENU** button (11).

The currently played track will then continue to be played normally.

Note:

You can set the scanning time. For further information, please read the section entitled "Setting the scanning time" in the "Radio mode" chapter.

Interrupting playback (PAUSE)

➡ Press the button **3** (5).

"PAUSE" appears on the display.

Cancelling pause

➡ During the pause, press the button **3** (5).

Playback is continued.

Configuring the display

You can choose from various display options in CD changer mode:

- CD number and track number
- CD number and time
- CD number and playing time
- Track number and playing time
- Track number and time

To switch between the display options,

➡ press the **ESC•DIS** button (9) once or several times for longer than 2 seconds.

Clock - Time

Displaying the time



To briefly display the time,

- press the **SOURCE**  button  for longer than two seconds.

The display changes and the time is shown for approx. 2 seconds.

Setting the time

To set the time,

- press the **MENU** button .
- Press the **↔** or **↵** button  repeatedly until "CLOCK SET" appears on the display.
- Press the **<** or **>** button  to open the menu.

The time appears on the display. The hours and minutes can be adjusted.

- Set the time using the **↔** or **↵** button .



To switch between hours and minutes,

- press the **<** or **>** button .

When you have finished making your changes,

- press the **MENU** button twice .

Selecting 12/24-hour clock mode



- Press the **MENU** button .
- Press the **↔** or **↵** button  repeatedly until "24 H MODE" or "12 H MODE" appears on the display.
- Press the **<** or **>** button  to switch between the modes.

When you have finished making your changes,

- press the **MENU** button .

Displaying the time continuously when the device is off and the ignition is on

To display the time when the device is off and the vehicle ignition is on,

- press the **MENU** button .
- Press the **↵** or **↔** button  repeatedly until "CLOCK OFF" or "CLOCK ON" appears on the display.
- Press the **<** or **>** button  to switch the display between CLOCK ON and CLOCK OFF.

When you have finished making your changes,

- press the **MENU** button .

Sound

You can adjust the sound settings (bass, middle and treble) separately for each source (radio, CD, CD changer, AUX, traffic announcement, telephone/navigation). The volume distribution settings (balance and fader) and X-BASS apply to all the audio sources except for traffic announcements and telephone/navigation. You can adjust the volume distribution settings separately for traffic announcements and telephone/navigation.

Note:

The settings of the sound for traffic announcements and telephone/navigation can only be made during a traffic announcement or during a telephone call/voice output.

Adjusting the bass

You can select 1 of 4 middle frequencies (60 Hz, 80 Hz, 100 Hz, 200 Hz). In addition, you can adjust the level between -7 and +7 for the selected bass frequency.

Adjusting bass frequency and level

➤ Press the **AUD** button (12).

"BASS" appears on the display.

➤ Press the **↔** or **↕** button (10) once to reach the BASS submenu.

➤ Press the **<** or **>** button (8) repeatedly until the desired bass frequency appears on the display.

➤ Press the **↔** or **↕** button (10) to adjust the level between -7 and +7.

➤ Press the **AUD** (12) button twice to exit the menu.

Note:

If an Equaliser preset (POP, ROCK, CLASSIC) is selected, the manual increase of the bass level does not result in an audible change starting at a certain setting. For further information, please read the note in the section entitled "Equaliser presets".

Adjusting the middle

You can select 1 of 4 centre frequencies (500 Hz, 1 kHz, 2 kHz, 3 kHz). In addition, you can adjust the level between -7 and +7 for the selected centre frequency.

Adjusting centre frequency and level

➤ Press the **AUD** button (12).

"BASS" appears on the display.

➤ Press the **<** or **>** button (8) repeatedly until "MIDDLE" appears on the display.

➤ Press the **↔** or **↕** button (10) once to reach the MIDDLE submenu.

➤ Press the **<** or **>** button (8) repeatedly until the desired centre frequency appears on the display.

➤ Press the **↔** or **↕** button (10) to adjust the level between -7 and +7.

➤ Press the **AUD** (12) button twice to exit the menu.

Adjusting the treble

You can select 1 of 4 treble frequencies (10 kHz, 12 kHz, 15 kHz, 17 kHz). In addition, you can adjust the level between -7 and +7 for the selected treble frequency.

Adjusting treble frequency and level

- Press the **AUD** button (12).
- "BASS" appears on the display.
- Press the < or > button (8) repeatedly until "TREBLE" appears on the display.
- Press the **↔** or **↵** button (10) once to reach the TREBLE submenu.
- Press the < or > button (8) repeatedly until the desired treble frequency appears on the display.
- Press the **↔** or **↵** button (10) to adjust the level between -7 and +7.
- Press the **AUD** (12) button twice to exit the menu.

Note:

If an Equaliser preset (POP, ROCK, CLASSIC) is selected, the manual increase of the treble level does not result in an audible change starting at a certain setting. For further information, please read the note in the section entitled "Equaliser presets".

Setting the left/right volume distribution (Balance)

To adjust the left/right volume distribution (balance),

- press the **AUD** button (12).
- "BASS" appears on the display.
- Press the < or > button (8) repeatedly until "BAL" appears on the display with the current setting.
- Press the **↔** or **↵** button (10) to adjust the balance (right/left).
- Press the **AUD** (12) button to exit the menu.

Adjusting the front/rear volume distribution (Fader)

To adjust the front/rear volume distribution (fader),

- press the **AUD** button (12).
- "BASS" appears on the display.
- Press the < or > button (8) repeatedly until "FADER" appears on the display with the current setting.
- Press the **↔** or **↵** button (10) to adjust the volume distribution front/rear.
- Press the **AUD** (12) button to exit the menu.

Preamplifier output (Preamp-Out/Sub-Out)

You can use the preamplifier outputs (Preamp-Out) of the car sound system to connect external amplifiers. In addition, you can connect an amplifier for operating a subwoofer to the integrated dynamic low-pass filter of the device (level and cutoff frequency can be adjusted).

For this purpose, the amplifiers must be connected as described in the installation instructions.

Adjusting the sub-out level

The sub-out level can be adjusted in 8 increments (0 to +7).

➤ Press the **AUD** button (12).

"BASS" appears on the display.

➤ Press the < or > button (8) repeatedly until "SUBOUT" appears on the display.

➤ Press the **▲** or **▼** button (10) once to reach the SUBOUT submenu.

➤ Press the **▲** or **▼** button (10) to adjust a value between 0 and +7.

When you have finished making your changes,

➤ press the **AUD** button (12) twice.

Adjusting the sub-out cutoff frequency

You can select 1 of 4 settings: 0 Hz, 80 Hz, 120 Hz and 160 Hz.

➤ Press the **AUD** button (12).

"BASS" appears on the display.

➤ Press the < or > button (8) repeatedly until "SUBOUT" appears on the display.

➤ Press the **▲** or **▼** button (10) once to reach the SUBOUT submenu.

➤ Press the < or > button (8) repeatedly until the desired frequency appears on the display.

When you have finished making your changes,

➤ press the **AUD** button (12) twice.

X-BASS

X-Bass allows you to increase the bass at low volume.

The selected X-Bass setting is effective for all audio sources (radio, CD, CD changer or AUX).

The X-BASS increase can be set in increments of 1 to 3.

"XBASS OFF" means that the X-BASS function is switched off.

Adjusting the X-BASS boost

- Press the **AUD** button (12).
- "BASS" appears on the display.
- Press the < or > button (8) repeatedly until "X-BASS" appears on the display.
- Press the **↶** or **↷** button (10) once to reach the X-BASS submenu.
- Press the **↶** or **↷** button (10) repeatedly until the desired setting appears on the display.

When you have finished making your changes,

- press the **AUD** button (12) twice.

Equalizer presets (Presets)

This device features an equaliser in which the settings for the music genres "ROCK", "POP" and "CLASSIC" are already programmed.

To select an equaliser setting,

- press the **AUD** button (12).
- "BASS" appears on the display.
- Press the < or > button (8) repeatedly until "POP", "ROCK", "CLASSIC" or "EQ OFF" appears on the display.
- Press the **↶** or **↷** button (10) to select one of the settings or select "EQ OFF" to switch off the equalizer.

When you have finished making your changes,

- press the **AUD** button (12).

Note:

Without Equaliser presets, you can adjust the bass and treble up to +7.

If you selected an Equaliser preset (POP, ROCK, CLASSIC), the adjustment of bass and treble is only limited. For example, the preset POP only allows for an audible treble adjustment up to +3.

Adjusting the display settings

Adjusting the display brightness

If your car sound system is installed as described in the installation instructions and your vehicle features the corresponding connection, the display brightness for day and night is switched by switching on the vehicle lighting. The display brightness can be adjusted separately for day and night in increments from 1 - 9.

- Press the **MENU** button (11).
- Press the **▲** or **▼** button (10) repeatedly until "DIM DAY" or "DIM NIGHT" appears on the display.
- Press the **<or>** button (8) to open the menu.
- Press the **<or>** button (8) to switch between the brightness levels.

When you have finished making your changes,

- press the **MENU** button twice (11).

Setting the display illumination colour

For the display illumination, you can mix a colour from the RGB spectrum (red green blue) or select a colour during a colour seek.

Mixing a colour for the display illumination

To customise the display illumination to suit your tastes you can mix a colour yourself using the three primary colours red, green and blue.

- Press the **MENU** button (11).
- Press the **▲** or **▼** button (10) repeatedly until "DISP COL" appears on the display.
- Press the **<or>** button (8) to open the menu.

The menu for mixing your own colour is displayed. "R", "G", and "B" are displayed with the current values. The setting for "R" is activated.

- Press the **▲** or **▼** button (10) repeatedly until the desired colour value is displayed.
- Press the **<or>** button (8) to move the selection marker to the position after the other colours.
- Adjust the other colour components to suit your preferences.

When you have finished making your changes,

- press the **MENU** button twice (11).

Selecting a display illumination during a colour scan

- Press the **MENU** button (11).
- Press the **↶** or **↷** button (10) repeatedly until "COL SCAN" appears on the display.
- Press the **<** or **>** button (8) to start the colour seek.

The device starts changing the display illumination colour.

To select the currently set colour,

- press the **MENU** button (11).

To start the seek tuning again,

- press the **<** or **>** button (8).

If you found the desired colour,

- press the **MENU** button twice (11).

External audio sources

External audio sources, such as portable CD players, MiniDisc players or MP3 players, can be connected to the device in two ways:

1. Via the rear AUX input (if no CD changer is connected to the device).

Notes:

- An adapter cable is needed to connect an external audio source via the rear AUX input. You can obtain this cable (Blaupunkt no.: 7 607 897 093) from your Blaupunkt dealer.
- The rear AUX input must be activated in the menu.
- The rear AUX input can be selected with the **SOURCE**  button (3). "AUX INPUT" then appears on the display.

2. Via the front AUX-IN socket.

Note:

As soon as an audio source is connected to the front AUX-IN socket, it can be selected with the **SOURCE**  button (3). "FRONT AUX" then appears on the display.

Switching the rear AUX input on/off

- Press the **MENU** button (11).
- Press the **√** or **⌫** button (10) repeatedly until "AUX OFF" or "AUX ON" appears on the display.
- Use the **<** or **>** button (8) to select between the options "AUX ON" and "AUX OFF".

When you have finished making your changes,

- press the **MENU** button (11).

Note:

If **no** CD changer is connected to the device, the AUX menu item cannot be selected.

Technical data

Amplifier

Output power:	4 x 18 watts sine at 14.4 V and 1% distortion factor at 4 ohms.
	4 x 26 watts sine in accordance with DIN 45324 at 14.4 V at 4 ohms.
	4 x 50 watts max. power

Tuner

Wavebands:	
FM	: 87.5 - 108 MHz
MW	: 531 - 1 602 kHz
LW	: 153 - 279 kHz

FM frequency response:	35 - 16,000 Hz
------------------------	----------------

CD

Frequency response:	20 - 20,000 Hz
---------------------	----------------

Pre-amp out

4 channels:	2 V
-------------	-----

Input sensitivity

AUX input:	2 V / 6 k Ω
Tel./Navi input:	10 V / 1 k Ω

Weight	1.36 kg
---------------	---------

Subject to changes

Bitte den ausgefüllten Gerätepass sicher aufbewahren!
Please keep the filled-in radio pass in a safe place!
Prière de conserver soigneusement la carte d'autoradio remplie !
Tenete per favore il libretto di apparecchio, debitamente riempito, in un posto sicuro!
Bewaar de ingevulde apparaatpas op een veilige plaats!
Vänligen förvara ifyllt apparatpass på säker plats!
¡Favor guardar el documento del aparato debidamente llenado en un lugar seguro!
Por favor, guardar o cartão preenchido do aparelho num lugar seguro!
Det udfyldte apparatpas opbevares et sikkert sted!
Prosimy przechowywać metrykę radia w bezpiecznym miejscu!
Vyplněný dokument o přístroji prosím bezpečně uschovejte!
Vyplněný dokument o přístroji prosím bezpečně uschovejte!

Country:	Phone:	Fax:	WWW:
Germany	(D) 0180-5000225	05121-49 4002	http://www.blaupunkt.com
Austria	(A) 01-610 39 0	01-610 39 391	
Belgium	(B) 02-525 5444	02-525 5263	
Denmark	(DK) 44 898 360	44-898 644	
Finland	(FIN) 09-435 991	09-435 99236	
France	(F) 01-4010 7007	01-4010 7320	
Great Britain	(GB) 01-89583 8880	01-89583 8394	
Greece	(GR) 210 94 27 337	210 94 12 711	
Ireland	(IRL) 01-46 66 700	01-46 66 706	
Italy	(I) 02-369 62331	02-369 62464	
Luxembourg	(L) 40 4078	40 2085	
Netherlands	(NL) 00 31 24 35 91 338	00 31 24 35 91 336	
Norway	(N) +47 64 87 89 60	+47 64 87 89 02	
Portugal	(P) 2185 00144	2185 00165	
Spain	(E) 902 52 77 70	91 410 4078	
Sweden	(S) 08-7501850	08-7501810	
Switzerland	(CH) 01-8471644	01-8471650	
Czech. Rep.	(CZ) 02-6130 0446	02-6130 0514	
Hungary	(H) 76 511 803	76 511 809	
Poland	(PL) 0800-118922	022-8771260	
Turkey	(TR) 0212-335 06 71	0212-346 00 40	
USA	(USA) 800-950-2528	708-6817188	
Brasil (Mercosur)	(BR) 0800 7045446	+55-19 3745 2773	
Malaysia (Asia Pacific)	(MAL) +604-6382 474	+604-6413 640	

11/06 - CM-AS/SCS1 (dt gb fr it nl sw es pt dk pl cz sk)

Gerätepass

Name: **London MP37**

Typ: **7 647 553 310**

Serien-Nr: **BP**

 **BLAUPUNKT**

